

# Origami Paper Christmas Tree

Translated from a design by Francesco Guarnieri - 2011

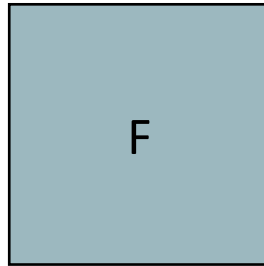
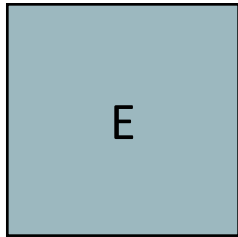
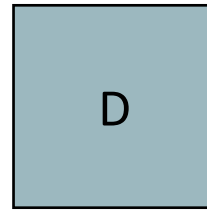
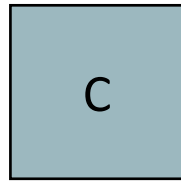
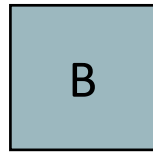

A = 11cm x 11cm

B = 13cm x 13cm

C = 15cm x 15cm

D = 17cm x 17cm

E = 19cm x 19cm

F = 21cm x 21cm

1

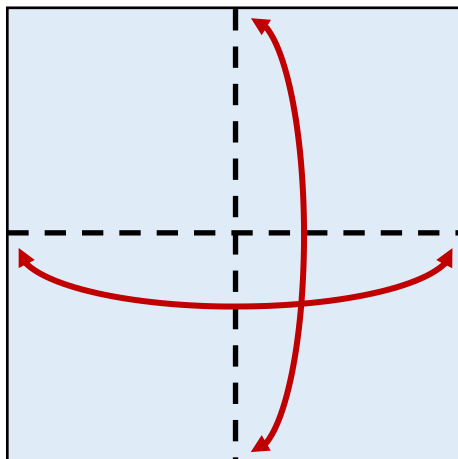

2

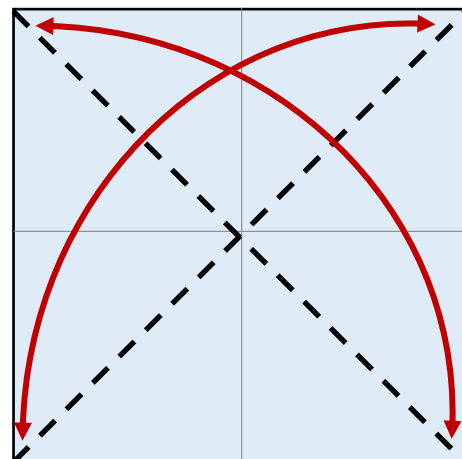

3

Flip square over and continue...

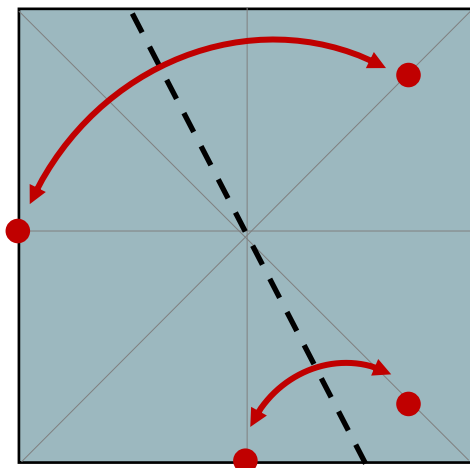

4

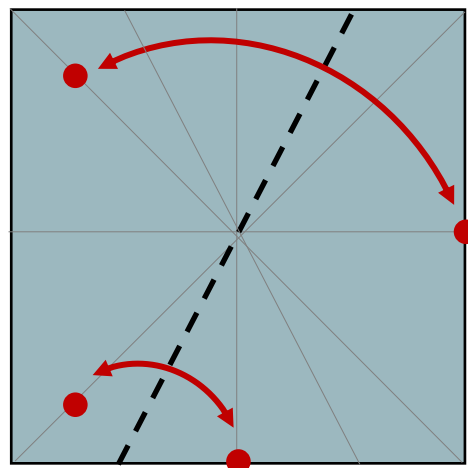

5

Rotate square 90 degrees and repeat steps 3 & 4 so that the square has the following folds visible...

6

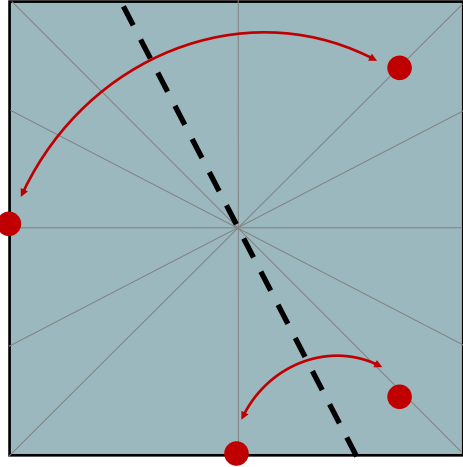

7

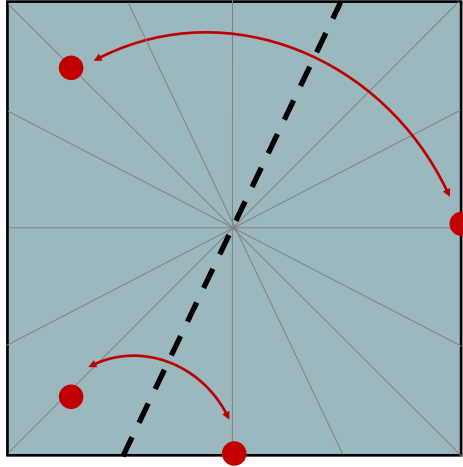

8

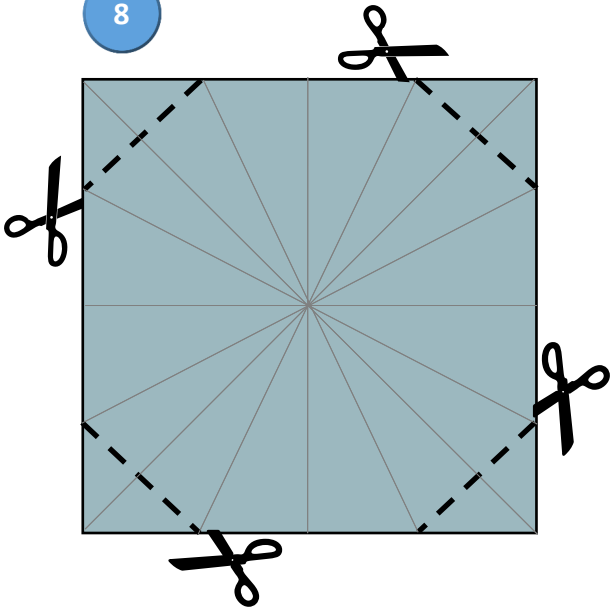

9

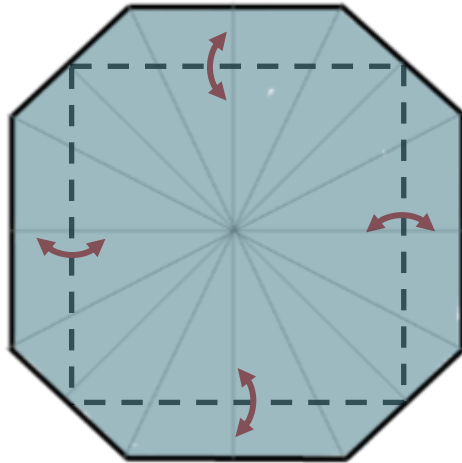

10

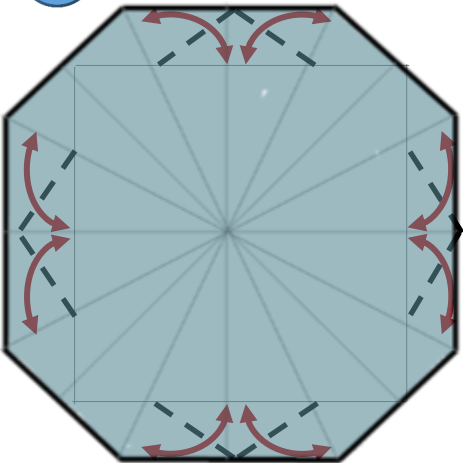

11

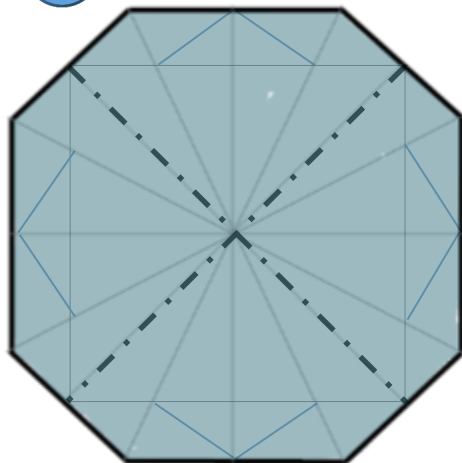

12

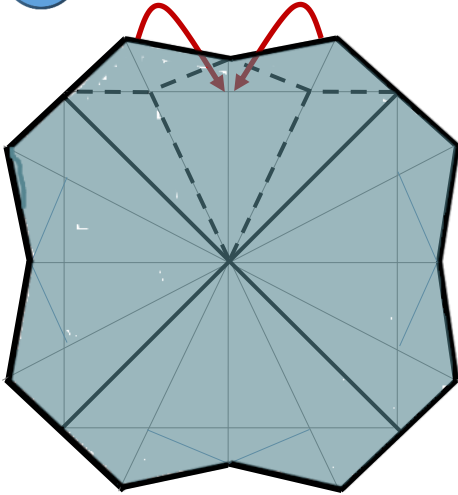

13

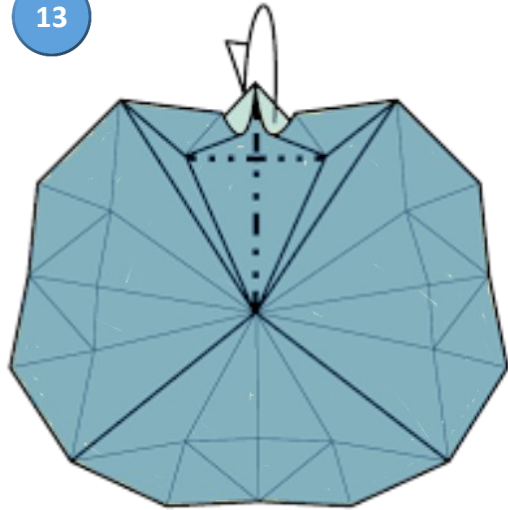

14

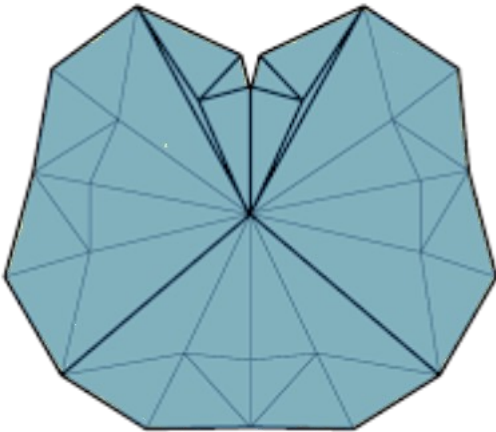

15

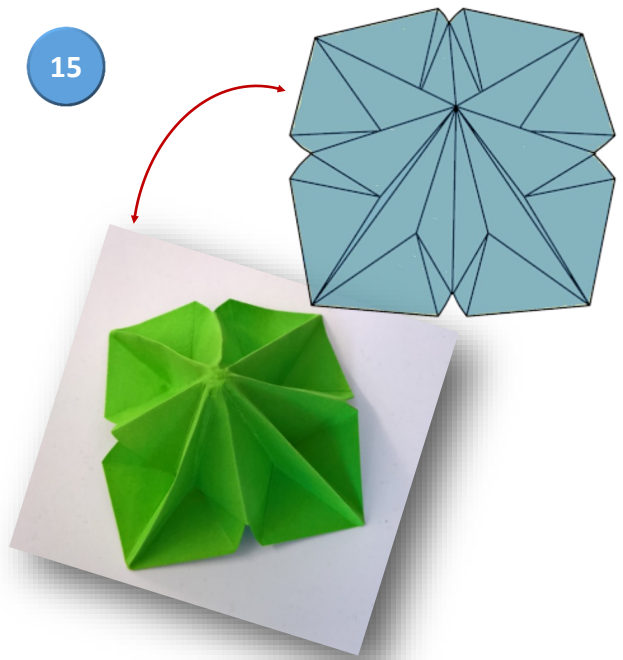

Rotate piece by 90 degrees and repeat steps 12, 13 & 14 so that this form is repeated on all four sides

15

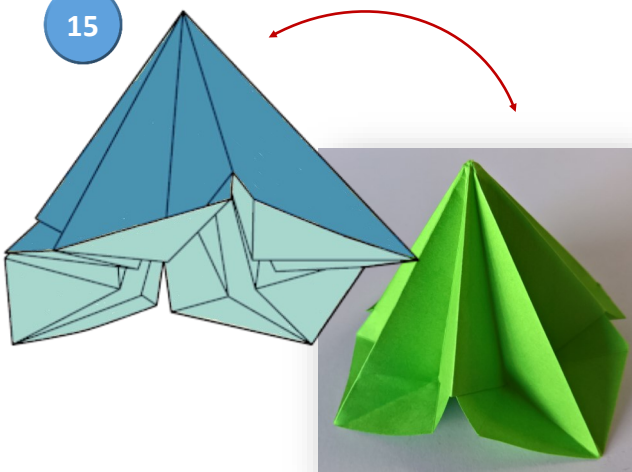

Repeat steps 1-15 with each of the 6 squares and stack to create the Christmas Tree—top with an origami Magic Star to complete.